

Serie Universal 1350

Protegge da:



Aria



Acqua



Luce



Insetti



Non costituisce ostacolo ai disabili

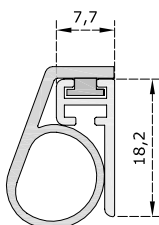
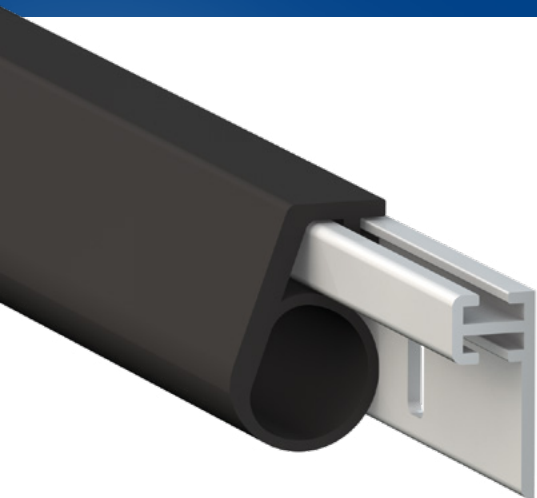

ACCESSORI STANDARD



DIMENSIONI: 80 - 100 - 120.

CARATTERISTICHE: Paraspifferi fisso con guarnizione in EPDM.

COMPONENTI: Profilo in alluminio lega 6060, guarnizione in EPDM.

IMBALLO: Scatola da 15 pezzi.

SISTEMA DI FISSAGGIO

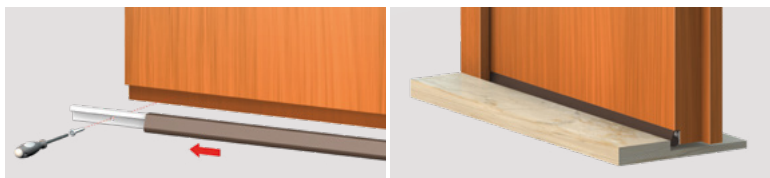

Avvita

APPLICAZIONI PRINCIPALI

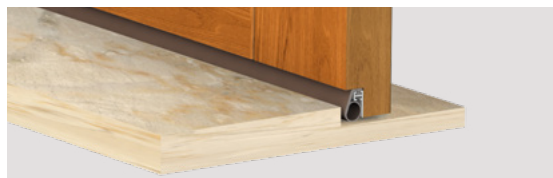

Porta in legno con soglia rialzata

Serie Universal 1355

Protegge da:



Aria



Acqua



Luce



Insetti



Non costituisce ostacolo ai disabili

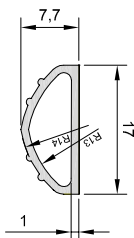
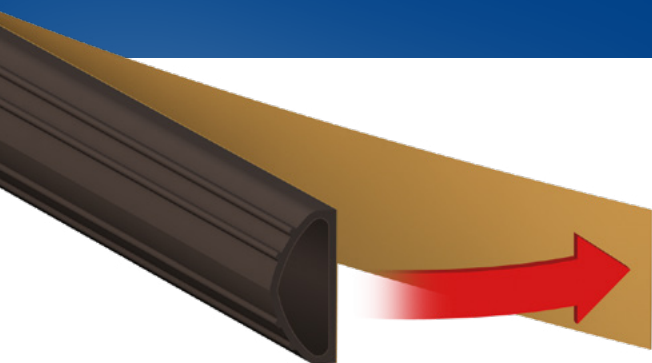

CARATTERISTICHE: Guarnizione tubolare adesiva perimetrale per telaio e porta.

COMPONENTI: guarnizione in EPDM, striscia adesiva.

IMBALLO: Confezione singola da 6 mt.

SISTEMA DI FISSAGGIO



Adesive

APPLICAZIONI PRINCIPALI

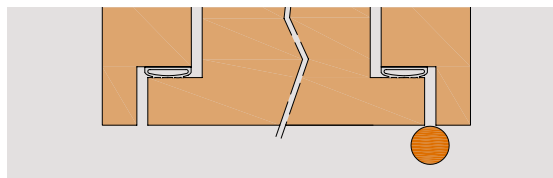

Porta in legno